

Apolo Kiosk

Datasheet

Welcome to oemKIOSKS



Touch...The Sky

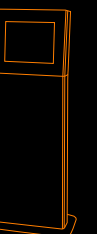

Apolo

Simplicity of lines

The Apolo model was developed for indoors use to work as stand up kiosk.

This model can be manufactured in stainless steel or painted steel (available in all RAL colors) using steel plate of 1,5mm to 2,5mm which ensures the stability and rigidity of the all structure.

This Galla model is normally equipped with a tactile monitor and can be delivered with a anti vandalism keyboard with trackball, card reader, webcam, coin acceptor, tickets printer, handset phone and other peripherals. This model can be equipped with a anti vandalic monitor.

The area where the computer is installed and possible peripherals (card readers, coin acceptors, etc.), is protected with access through a security lock and includes three power plugs.

The Apolo Model is normally equipped with a 17" SXGA touchscreen display (SAW) (19" to 24" are other possible sizes).

On the side of the monitor are two speakers and the kiosk has 2 independent systems of ventilation, one for the monitor and other for the PC.

The Apolo Model is normally equipped with a Atom CPU with a 160 GB hard drive, 1 Gb Ram Memory, a 128Mb graphic card and a 10/100 mb ethernet, Windows 7 Starter.

Technical Specifications Apolo Kiosk

Dimensions: H1500 x W500 x D300

Weight: aprox. 45 Kg.

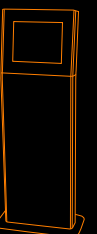

Apolo

Distance comparison and main features

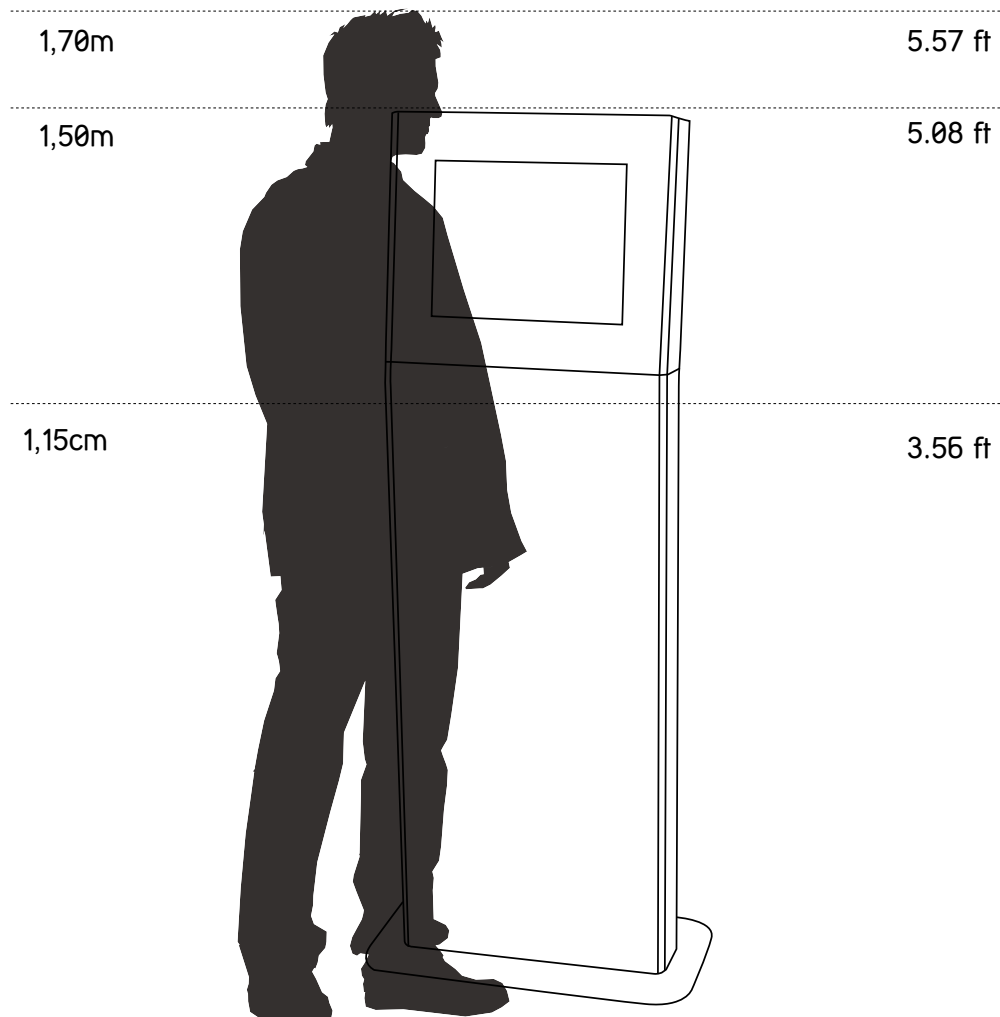

Type

Indoor

Materials

Painted Steel

Stainless Steel

MDF

Options

Webcam

Ticket Printer

Card Reader

Antivandalic Keyboard

Bar Code Scanner

Handset Phone

Coin Validator

Bill Validator

A4 Printer (SlimwXL)

Ykiosk Software

Distance comparison and main features

Apolo

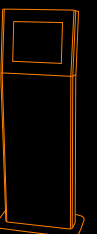

Apolo

Kiosk measures

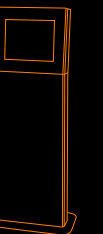
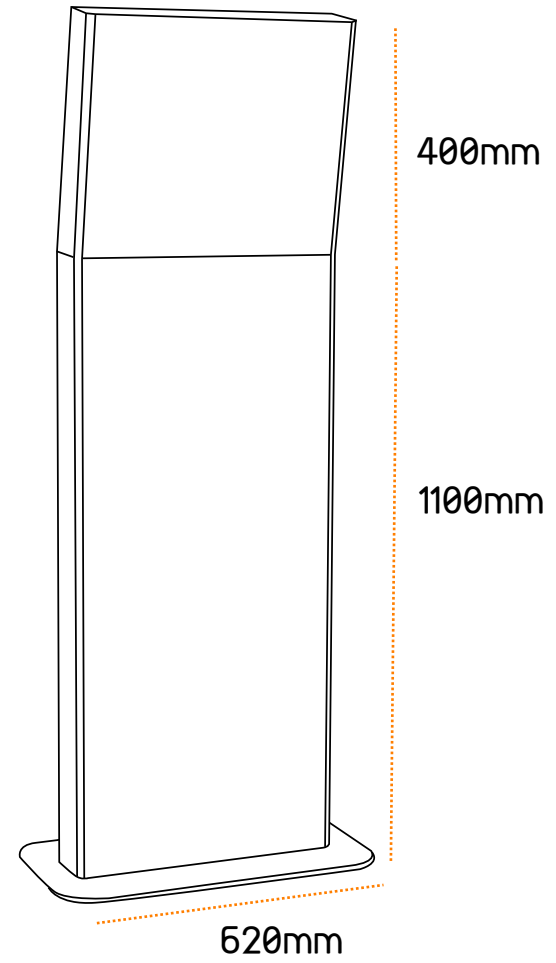
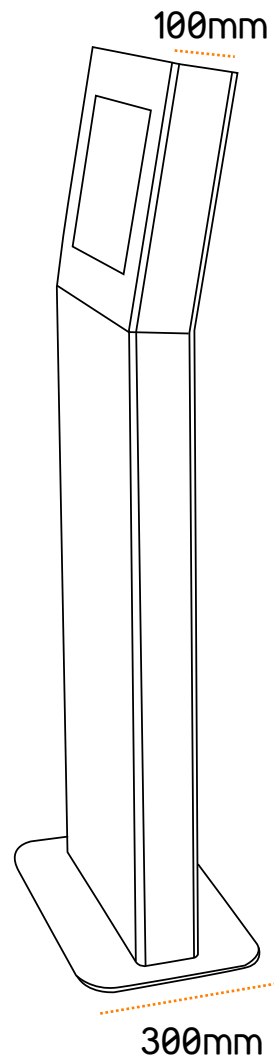
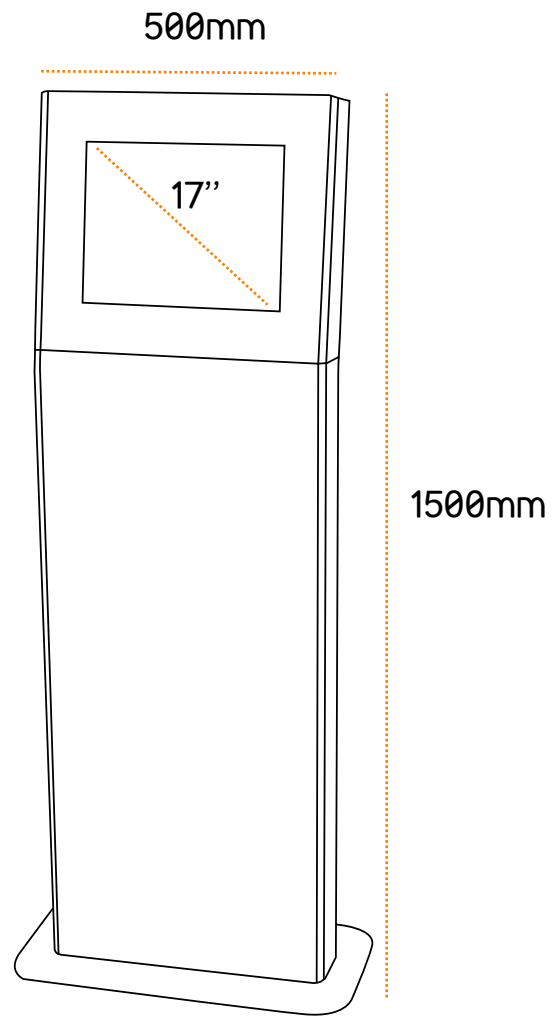

Apolo

Technical data

Dimensions:

- 17" Display (resolution: 1280 x 1024 Pixel)
- H1550 W500 D400

Weight:

45 kg

Configuration:

- Larger Interactivity
- Stainless steel AISI304 or painted steel (RAL Colors)
- Steel plate of 1,5mm to 2,5mm
- 17" SXGA touchscreen display (SAW)
- Integrated speakers

Optional:

- 19" to 24" Displays
- Atom or Dual Core PC computer
- Microsoft Windows 7 Professional
- Ykiosk software package
- Antivandalic Keyboard
- Touchscreen (Infrared, optical, capacitive)
- Wireless networking - WLAN
- Bluetooth functionality
- Webcam

• Other components can be integrated changing kiosk dimensions: ticket printer, coin validator, bill validator, card readers, antivandalic keyboard, proximity sensor, etc.

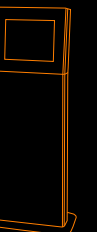

oemKIOSKS | Your white label kiosk company

This document is provided only for information purposes. The presented information is subject to change without prior notice, given the constant evolution of content.
THE PARTTEAM GROUP is not responsible for any errors or omissions in this document, based on the information it contains, as a result of its publication.



oemKIOSKS | Partteam Group Portugal | Rua Nova da Nespereira, Pavilhão 10 | 4770 -287 Lagoa - Vila Nova de Famalicão
tel: +351 252 378 589 | +351 252 327 185 | fax: + 351 252 378 591 | Portugal
www.oemkiosks.com | oem@oemkiosks.com