

Shine Kiosk

PATENTED - DESIGN MODEL N°. 2034

Datasheet

Welcome to oemKIOSKS



Touch...The Sky



Shine

The materials revolution

Technical Specifications Shine Model

Dimensions: H1450 x W500 x D100

Acrylic deep: 20

Weight: aprox. 40 Kg.

The Shine model was developed for indoors use to work as stand up kiosk.

The new Shine model results from a combination of the great aesthetic acrylic and stainless steel or lacquered. This model was designed for use indoors.

This model is practically made in a 20 mm Acrylic giving it an aesthetic and innovative design.

This model is normally equipped with a 17 " antivandalic touch screen with 3 / 4 mm.

The area where the PC will be installed has security locks, general switch and is easily detachable, leaving enough space for the installation and access to a minitower PC.

The base of the Shine Kiosk can be manufactured in stainless steel or painted steel (available in all RAL colors) using steel plate of 1,5mm to 2,5mm and can have 2 speakers if the sound is necessary for the case.

The Shine Model is normally equipped with a Atom CPU with a 160 GB hard drive, 1 Gb Ram Memory, a 128Mb graphic card and a 10/100 mb ethernet, Windows 7 Starter.

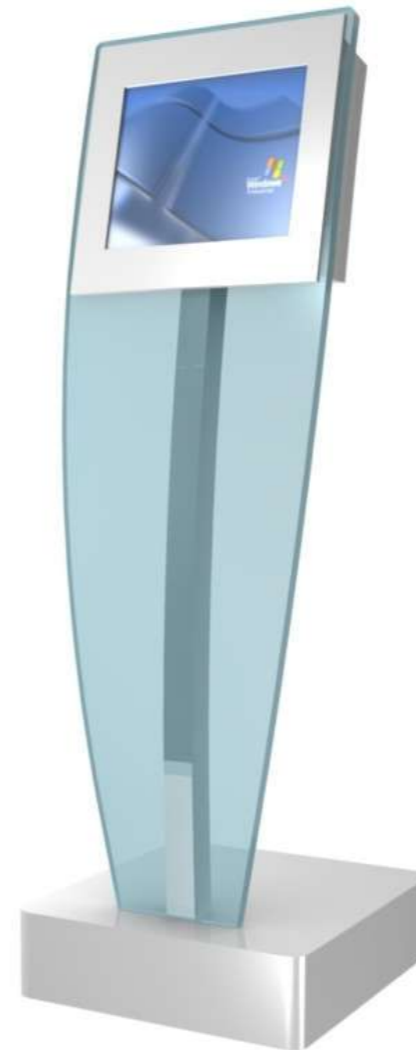

PATENTED - DESIGN MODEL N°. 2034

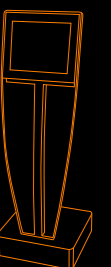

Shine

Distance comparison and main features

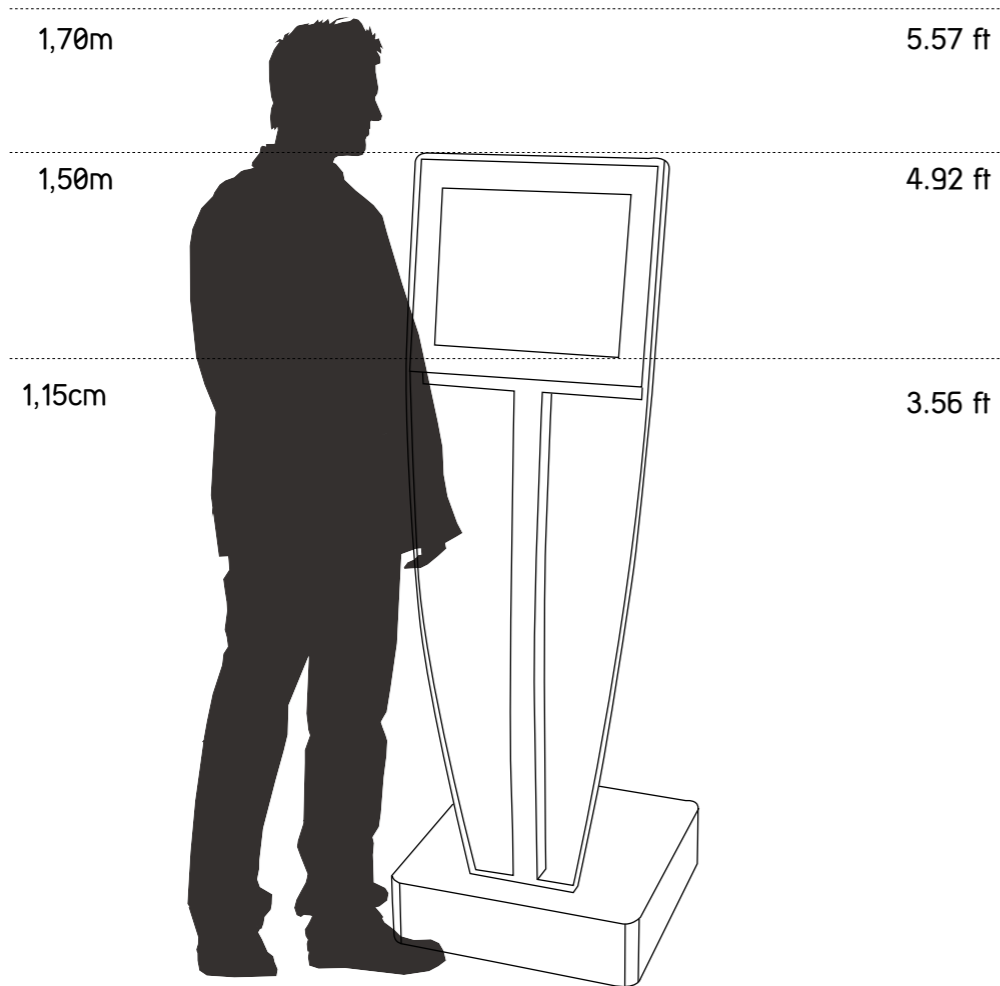

Type

Indoor

Materials

Painted Steel

Stainless Steel

MDF

Options

Webcam

Ykiosk Software

Distance comparison and main features

Shine



Shine

Kiosk measures

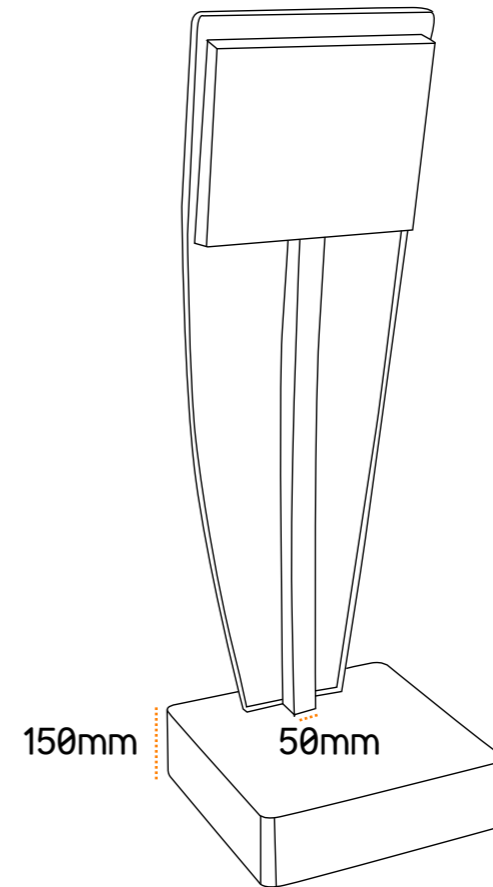
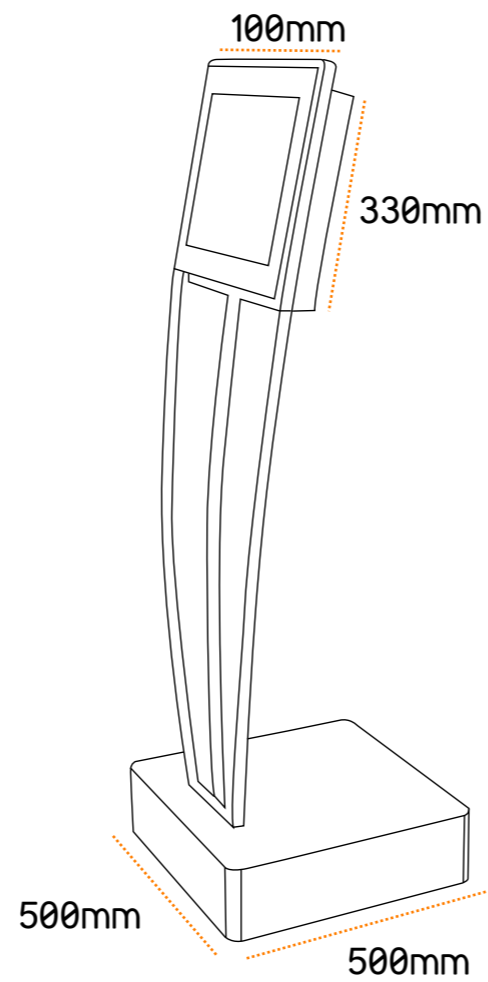
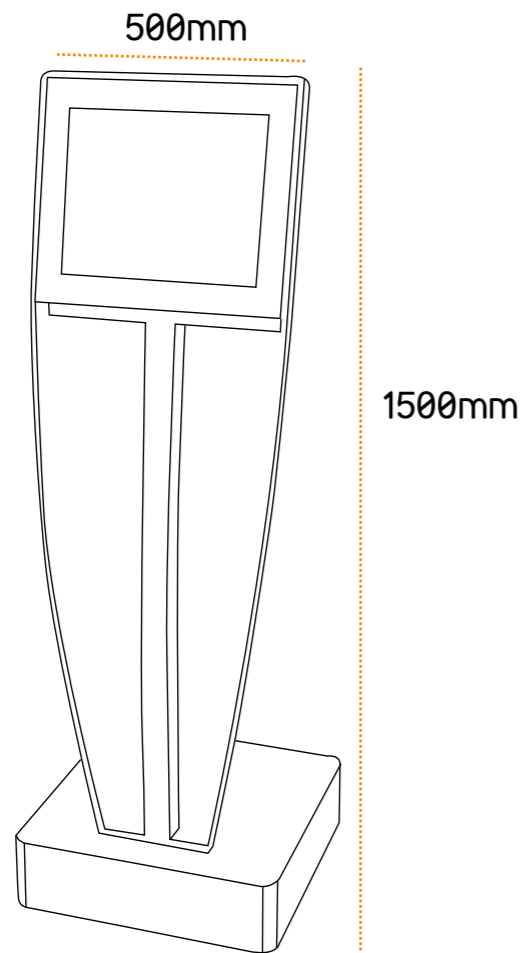

Shine

Technical data

Dimensions:

- 17" Display (resolution: 1280 x 1024 Pixel)
- H1450 W500 D100
- Acrylic deep: 20mm

Weight:

40 kg

Configuration:

- The Materials Revolution
- Stainless steel AISI304 or painted steel (RAL Colors)
- Steel plate of 1,5mm to 2,5mm
- 17" XGA touchscreen display (resistive)
- Integrated speakers

Optional:

- 19" to 24" Displays
- Atom or Dual Core PC computer
- Microsoft Windows 7 Professional
- Ykiosk software package
- Antivandalic Keyboard
- Touch screen (SAW - antivandalism)
- Wireless networking - WLAN
- Bluetooth functionality
- Webcam

• Other components can be integrated changing kiosk dimensions: ticket printer, coin validator, bill validator, card readers, antivandalic keyboard, proximity sensor, etc.

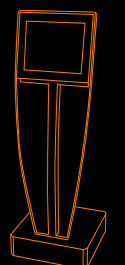

oemKIOSKS | Your white label kiosk company

This document is provided only for information purposes. The presented information is subject to change without prior notice, given the constant evolution of content.
THE PARTTEAM GROUP is not responsible for any errors or omissions in this document, based on the information it contains, as a result of its publication.



oemKIOSKS | Partteam Group Portugal | Rua Nova da Nespereira, Pavilhão 10 | 4770 -287 Lagoa - Vila Nova de Famalicão
tel: +351 252 378 589 | +351 252 327 185 | fax: + 351 252 378 591 | Portugal
www.oemkiosks.com | oem@oemkiosks.com