

Dali Kiosk

Datasheet

Welcome to oemKIOSKS



Touch...The Sky



Dali

Compact and Versatile

Technical Specifications Dali Kiosk

Dimensions: H880 x W550 x D250
Weight: aprox. 35 Kg.

The Dali Model was developed both for indoor or outdoor use, particularly for placing in walls or on top of a table/balcony.

This model is manufactured in stainless steel AISI304 or painted steel (RAL Colors) using steel plate of 1,5mm to 2,5mm which ensures the stability and rigidity of all structure.

The area where the computer is installed and possible peripherals (card readers, coin acceptors, etc.), is protected with access through a security lock and includes three power plugs.

On side of display are two integrated speakers that fits smoothly in the all structure.

The Dali Model is normally equipped with a 17" SXGA touchscreen display (SAW) - 19", 22" or other sizes are possible

They are equipped with high-performance computer, with any range of CPU, 160 GB hdd or higher, 2 GB RAM, 10/100 Mb network card and any operating system (Windows, Linux, etc.), but is usually equipped Windows 7 Home or Professional Edition.



Compact and Versatile

Dali

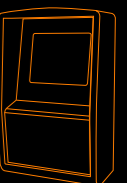

Dali

Distance comparison and main features

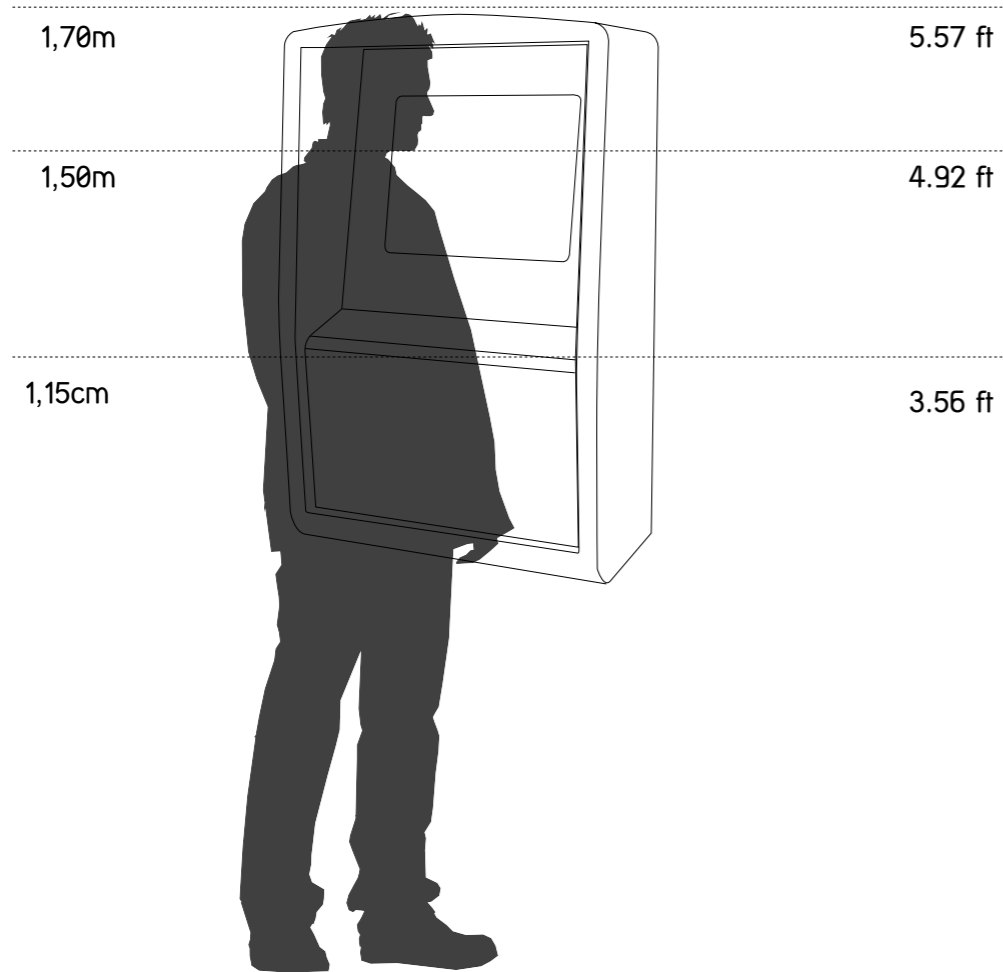

Type

- Indoor / Outdoor

Materials

- Painted Steel
- Stainless Steel
- MDF

Options

- Webcam
- Ticket Printer
- Card Reader
- Antivandalic Keyboard
- Bar Code Scanner
- Handset Phone
- Coin Validator
- Bill Validator
- Ykiosk Software

Distance comparison and main features

Dali

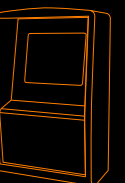

Dali

Kiosk measures

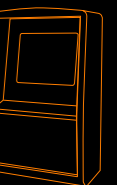
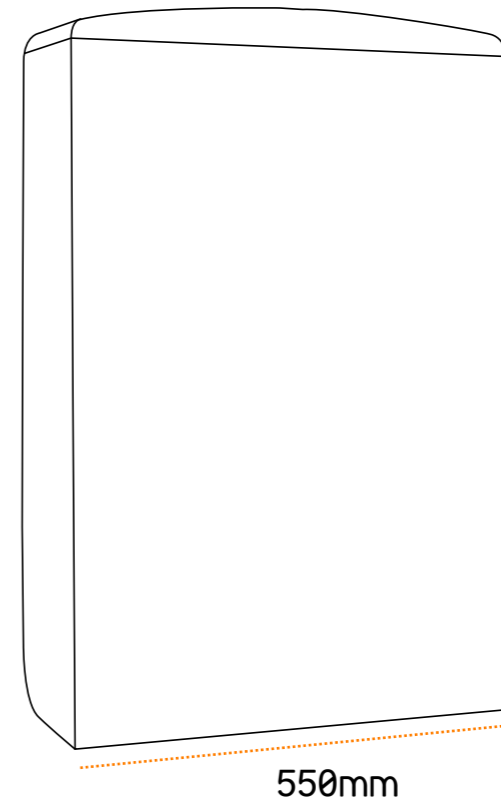
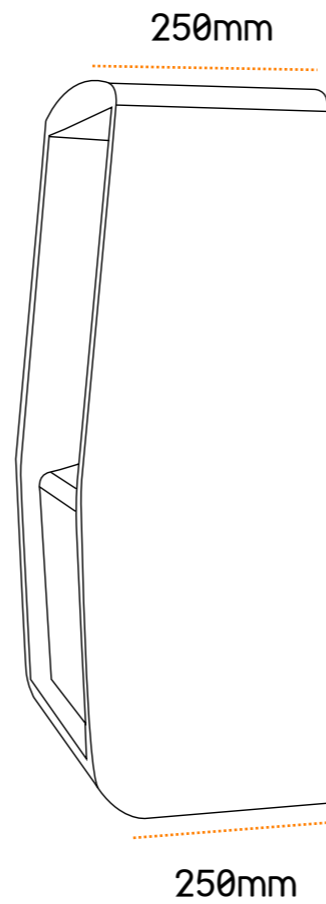
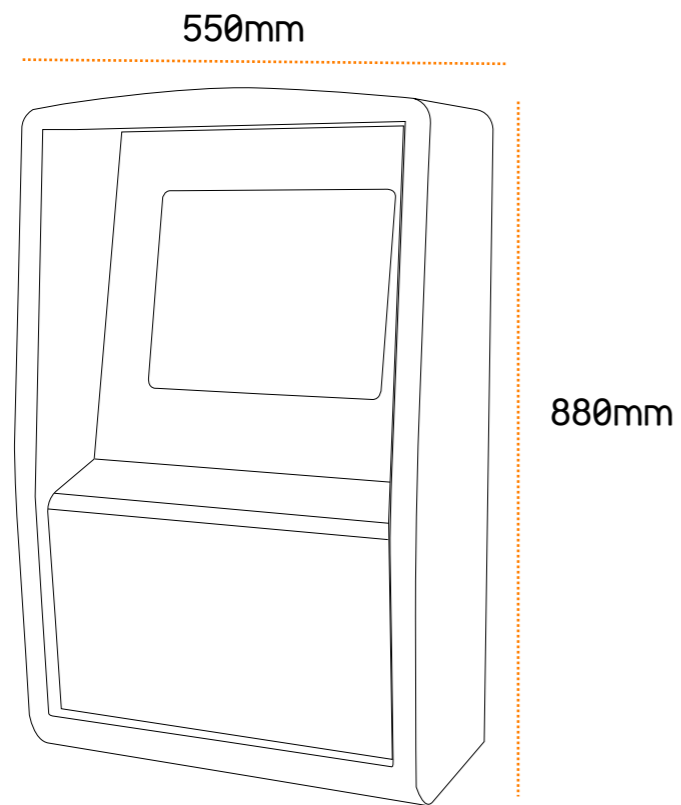

Dali

Technical data

Dimensions:

- 17 inch (resolution: 1280 x 1024 Pixel)
- H880 W550 D250

Weight:

35 kg

Configuration:

- Stainless steel AISI304 or painted steel (RAL Colors)
- Steel plate of 1,5mm to 2,5mm
- 17" SXGA touchscreen display (SAW)
- Integrated speakers

Optional:

- 17" display or higher
- Atom or Dual Core PC computer
- Microsoft Windows 7 Professional
- Ykiosk software package
- Touchscreen (Infrared, optical, capacitive)
- Wireless networking - WLAN
- Bluetooth functionality
- Webcam

• Other components can be integrated changing kiosk dimensions: ticket printer, coin validator, bill validator, card readers, antivandalic keyboard, proximity sensor, etc.

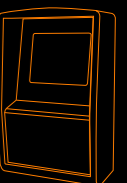

oemKIOSKS | Your white label kiosk company

This document is provided only for information purposes. The presented information is subject to change without prior notice, given the constant evolution of content.
THE PARTTEAM GROUP is not responsible for any errors or omissions in this document, based on the information it contains, as a result of its publication.



oemKIOSKS | Partteam Group Portugal | Rua Nova da Nespereira, Pavilhão 10 | 4770 -287 Lagoa - Vila Nova de Famalicão
tel: +351 252 378 589 | +351 252 327 185 | fax: + 351 252 378 591 | Portugal
www.oemkiosks.com | oem@oemkiosks.com