

Wall Kiosk

Datasheet

Welcome to oemKIOSKS



Touch...The Sky

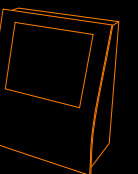

Wall

Compact and versatile

Technical Specifications Wall Kiosk

Dimensions: H500 x W500 x D200
Wiegth: aprox. 30 Kg.

The Wall Model was developed specifically for indoor use, particularly for placing on the top of a desk or in a fixed mural.

This model can be manufactured in stainless steel or painted steel (available in all RAL colors) using steel plate of 1,5mm to 2,5mm which ensures the stability and rigidity of the all structure.

The area where the computer is installed and possible peripherals (card readers, coin acceptors, etc.), is protected with access through a security lock and includes a base with three power plugs.

On the side of the monitor are two integrated speakers that fits smoothly in the all structure.

The Wall Model is normally equipped with a 17" XGA touch display (19", 22" or other sizes are possible).

The Wall Model is normally equipped with a Atom CPU with a 160 GB hard drive, 1 Gb Ram Memory, a 128Mb graphic card and a 10/100 mb ethernet, Windows 7 Starter (Optional: dual core CPU, Wireless, Bluetooth, Windows XP Pro, 2gb Ram).



Compact and versatile

Wall

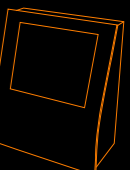

Wall

Distance comparison and main features

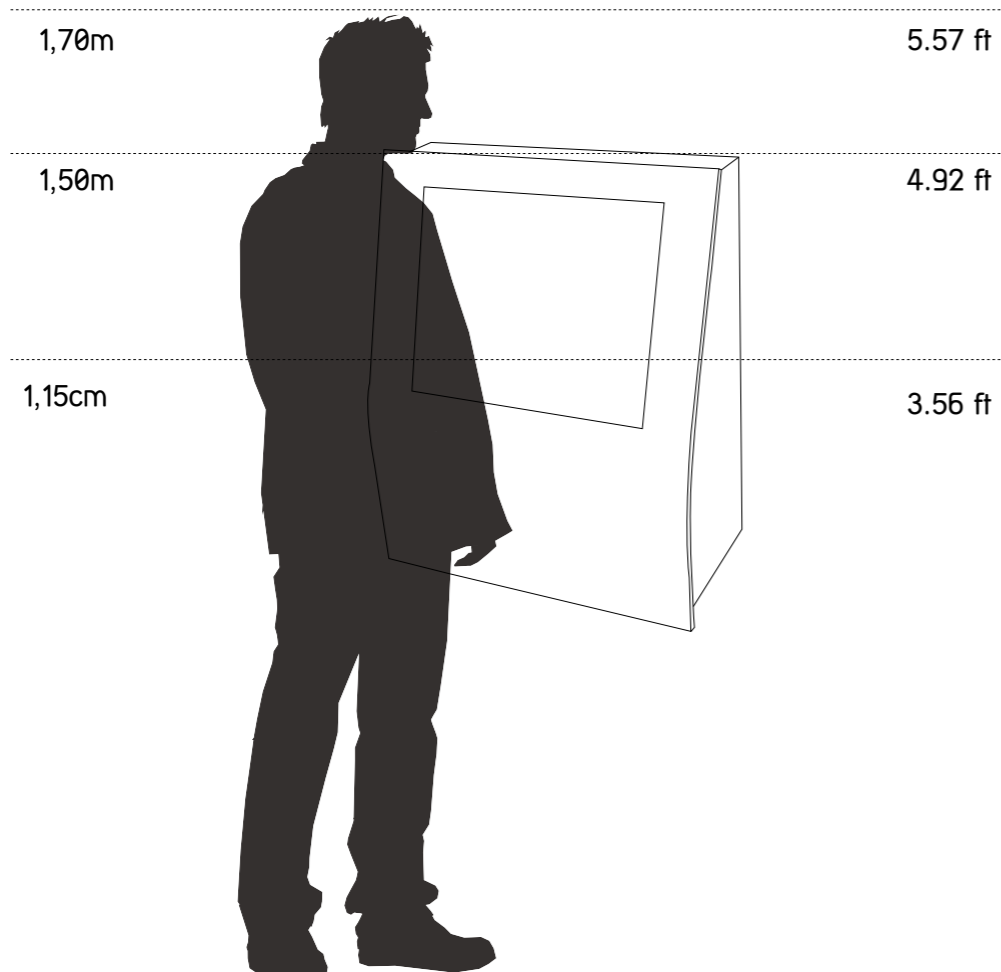

Type

Indoor

Materials

Painted Steel

Stainless Steel

MDF

Options

Webcam

Ticket Printer

Card Reader

Antivandalic Keyboard

Bar Code Scanner

Handset Phone

Coin Validator

Bill Validator

Ykiosk Software

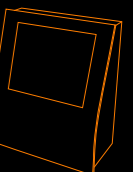

Wall

Kiosk measures

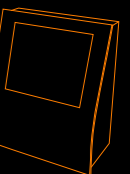
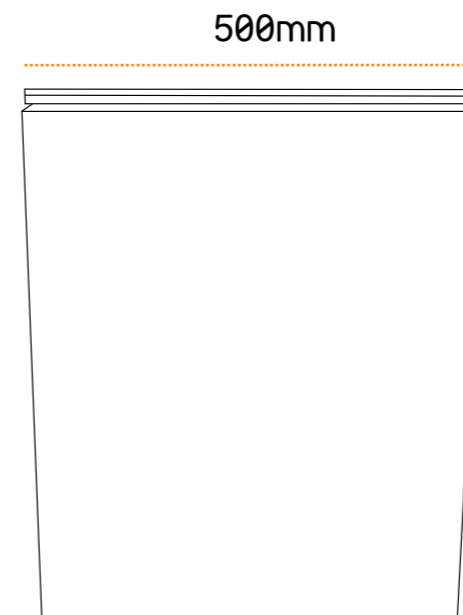
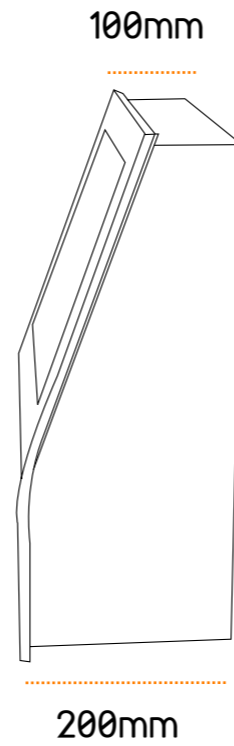
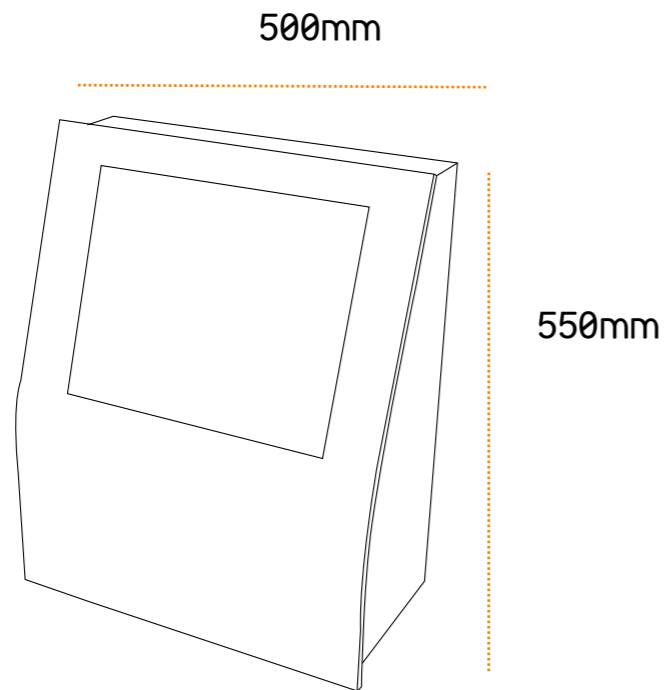

Wall

Technical data

Dimensions:

- 17 inch (resolution: 1280 x 1024 Pixel)
- H500 W500 D200

Weight:

30 kg

Configuration:

- Compact and versatile
- Stainless steel AISI304 or painted steel (RAL Colors)
- Steel plate of 1,5mm to 2,5mm
- 17" XGA touchscreen display (resistive)
- Integrated speakers

Optional:

- 19" to 24" Displays
- Atom or Dual Core PC computer
- Microsoft Windows 7 Professional
- Ykiosk software package
- Touch screen (SAW - antivandalism)
- Wireless networking - WLAN
- Bluetooth functionality
- Webcam

• Other components can be integrated changing kiosk dimensions: ticket printer, coin validator, bill validator, card readers, antivandalic keyboard, proximity sensor, etc.

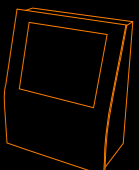

oemKIOSKS | Your white label kiosk company

This document is provided only for information purposes. The presented information is subject to change without prior notice, given the constant evolution of content.
THE PARTTEAM GROUP is not responsible for any errors or omissions in this document, based on the information it contains, as a result of its publication.



oemKIOSKS | Partteam Group Portugal | Rua Nova da Nespereira, Pavilhão 10 | 4770 -287 Lagoa - Vila Nova de Famalicão
tel: +351 252 378 589 | +351 252 327 185 | fax: + 351 252 378 591 | Portugal
www.oemkiosks.com | oem@oemkiosks.com